

Research Documentation  
February 2016

---

Hugh Magee

Miho Mazereeuw

Aditya Barve

Johanna Greenspan-Johnston



# HIMALAYAN BELT REGION

The Himalayan Region is the youngest mountain region in the world. Formed by the plate collision of the Indian subcontinent and the Eurasian plate, it is prone to frequent earthquakes, flash floods and landslides.<sup>1</sup> Historically the urbanization in the region has been limited to few broad valley areas such as Kathmandu in Nepal and Srinagar in Kashmir. In the recent past however, the region has witnessed rapid urbanization with the population more than tripling in the period between the early 1900's from 11 million to and 33 million by the 1980's.<sup>2</sup> Today population growth varies across the region from 2.1 to 4.3 per annum resulting in an estimated doubling within the next 30 years. As such "Himalaya represents one of (...) the most densely populated mountain ecosystems on the planet."<sup>3</sup>

---

1 Tiwari, P. "Urban and Environmental Changes in Himalaya: A Study of the Lake Region of District Nainital in Kumaon Himalaya, India." International Working Paper Series (December, 2007).

2 AAAS, Atlas of Population and Environment, <http://atlas.aaas.org/index.php?part=3&sec=him>

3 Tiwari, P. "Urban and Environmental Changes in Himalaya: A Study of the Lake Region of District Nainital in Kumaon Himalaya, India." International Working Paper Series (December, 2007).

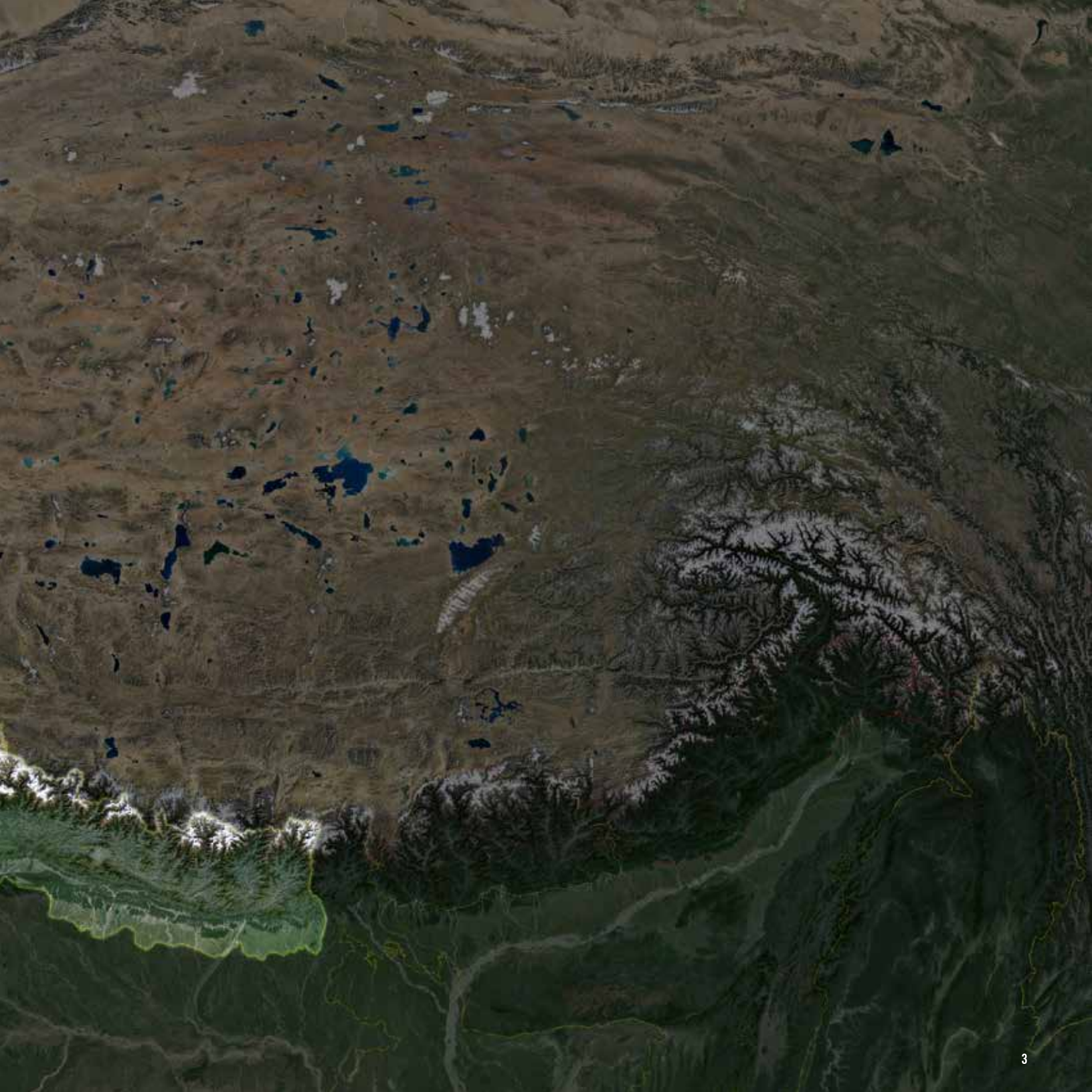

# URBANIZATION & POPULATION DENSITY

The urbanization of this region manifests itself in the growth of mostly unplanned urban settlements; remote villages and towns grow without oversight from municipal organizations either due to lack of resources or capacity from government or lack of access due to topography.

Consequently, in this ecologically fragile and tectonically alive region the severity of natural risks to urban settlement either from earthquakes or storm water discharge as flash floods and landslides is augmented. Additionally man-made risks associated with water scarcity are impacted by unplanned urban growth as pollution from construction and poor sanitation practices adversely affect natural water ways. Although key cities in the region are small compared to other cities in south Asia, their economy is based on tourism; during the summer season their population can quadruple. This seasonal influx together with the general population growth of the Himalayan region has had major impacts on larger urban centers, yet the vast majority of Himalayans occupy rural and peri-urban settlements, more vulnerable to natural risks due to lack of development and poverty.

## Continental Collision

As the Indian subcontinent pushes against Eurasia, pressure is released in the form of earthquakes. The constant crashing of the two plates forms the Himalayan mountain range.

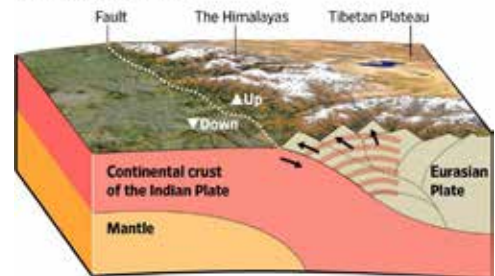

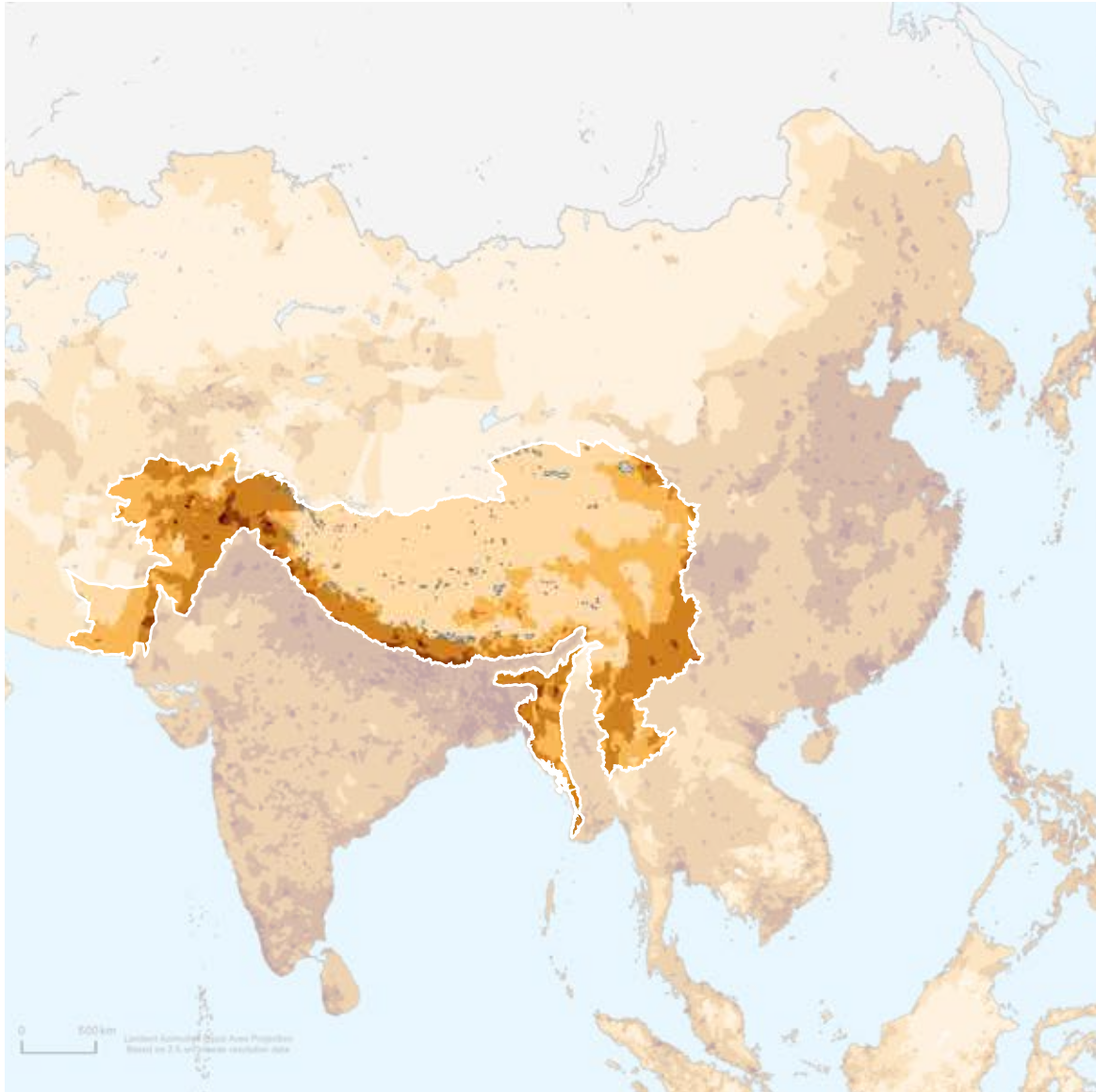
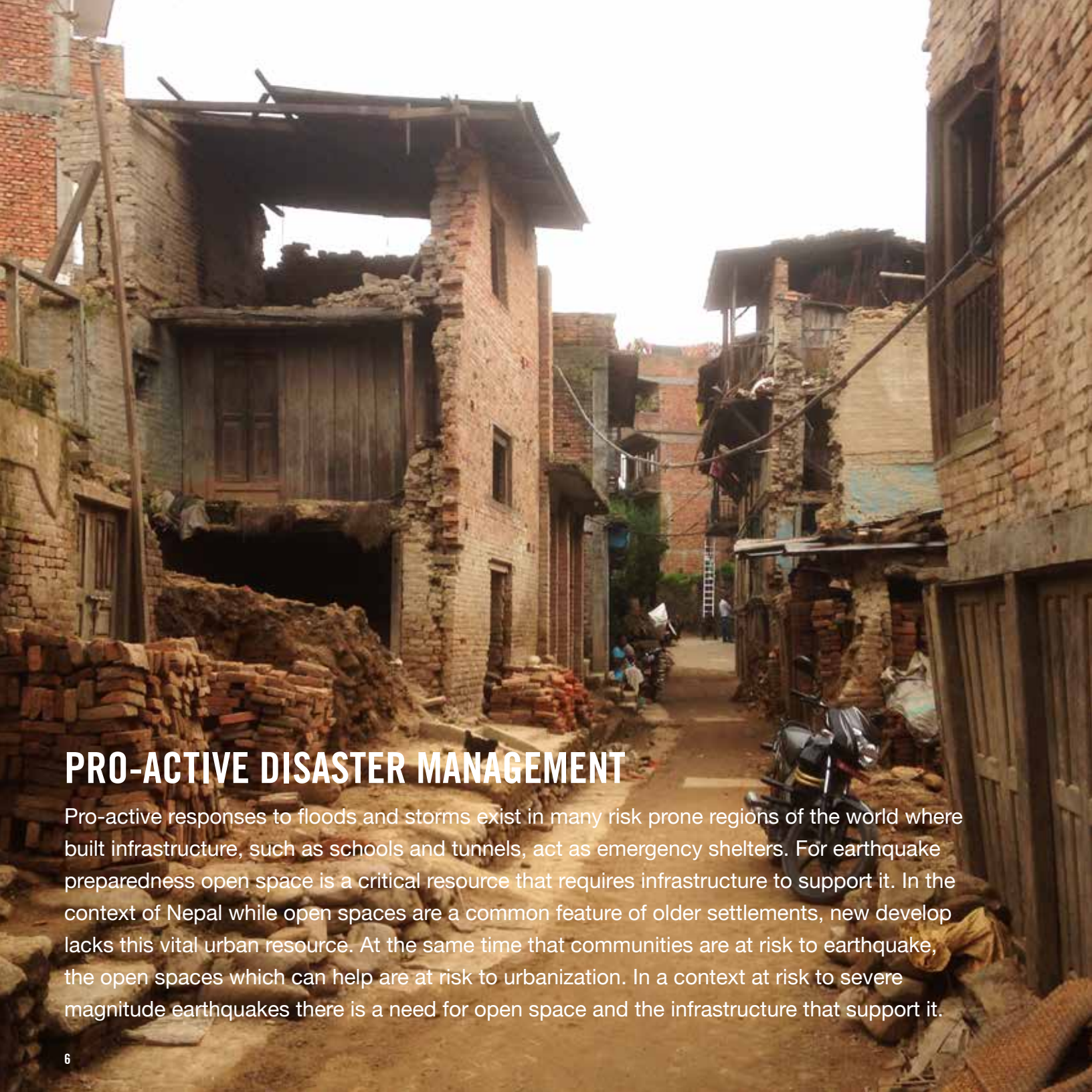

Figure 1. Hindu Kush Himalaya Population Density.  
Gridded Population Of The World, Version 3 (Gpw3): Population Density Grid. Palisades, Ny: Nasa Socioeconomic Data And Applications Center (Sedac). <http://Dx.doi.org/10.7927/H4xk8cg2>. Accessed February 26, 2016.



## PRO-ACTIVE DISASTER MANAGEMENT

Pro-active responses to floods and storms exist in many risk prone regions of the world where built infrastructure, such as schools and tunnels, act as emergency shelters. For earthquake preparedness open space is a critical resource that requires infrastructure to support it. In the context of Nepal while open spaces are a common feature of older settlements, new develop lacks this vital urban resource. At the same time that communities are at risk to earthquake, the open spaces which can help are at risk to urbanization. In a context at risk to severe magnitude earthquakes there is a need for open space and the infrastructure that support it.

RISK

EMERGENCY RESPONSE

SHORT AND LONG TERM NEEDS



**STORM**



MOVE DOWN

SHORT TERM RESPONSES REQUIRE GETTING TO SHELTER, INDOORS, IDEALLY UNDERGROUND  
IN MANY AREAS PRONE TO SEVERE STORMS UNDERGROUND SHELTERS ARE CONSTRUCTED



**FLOOD**



MOVE UP

SHORT TERM RESPONSES REQUIRE GETTING TO HIGHER GROUND



**EARTHQUAKE**

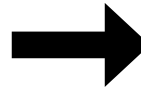

MOVE OUT

SHORT TERM RESPONSE REQUIRE GETTING OUTSIDE INTO OPEN SPACE. OVER THE MEDIUM TERM THERE IS A NEED FOR TEMPORARY SHELTER WHICH IN ITSELF REQUIRES OPEN SPACE AND INFRASTRUCTURE TO SUPPORT IT. (WATER, POWER, MEDICAL SUPPLIES, COMMUNICATIONS, ETC)

# HIMALAYAN RISK MAP

## LOCATIONS OF RECENT EARTHQUAKES

THE APRIL 2015 EARTHQUAKE DEMONSTRATED NEPAL'S CONTINUING VULNERABILITY TO EARTHQUAKE. THE KATHMANDU VALLEY, BEING ONE OF THE LARGEST URBAN CENTERS, REMAINS IN A STATE OF RECOVERY WHILE IT PREPARES FOR THE NEXT MAJOR SEISMIC EVENT



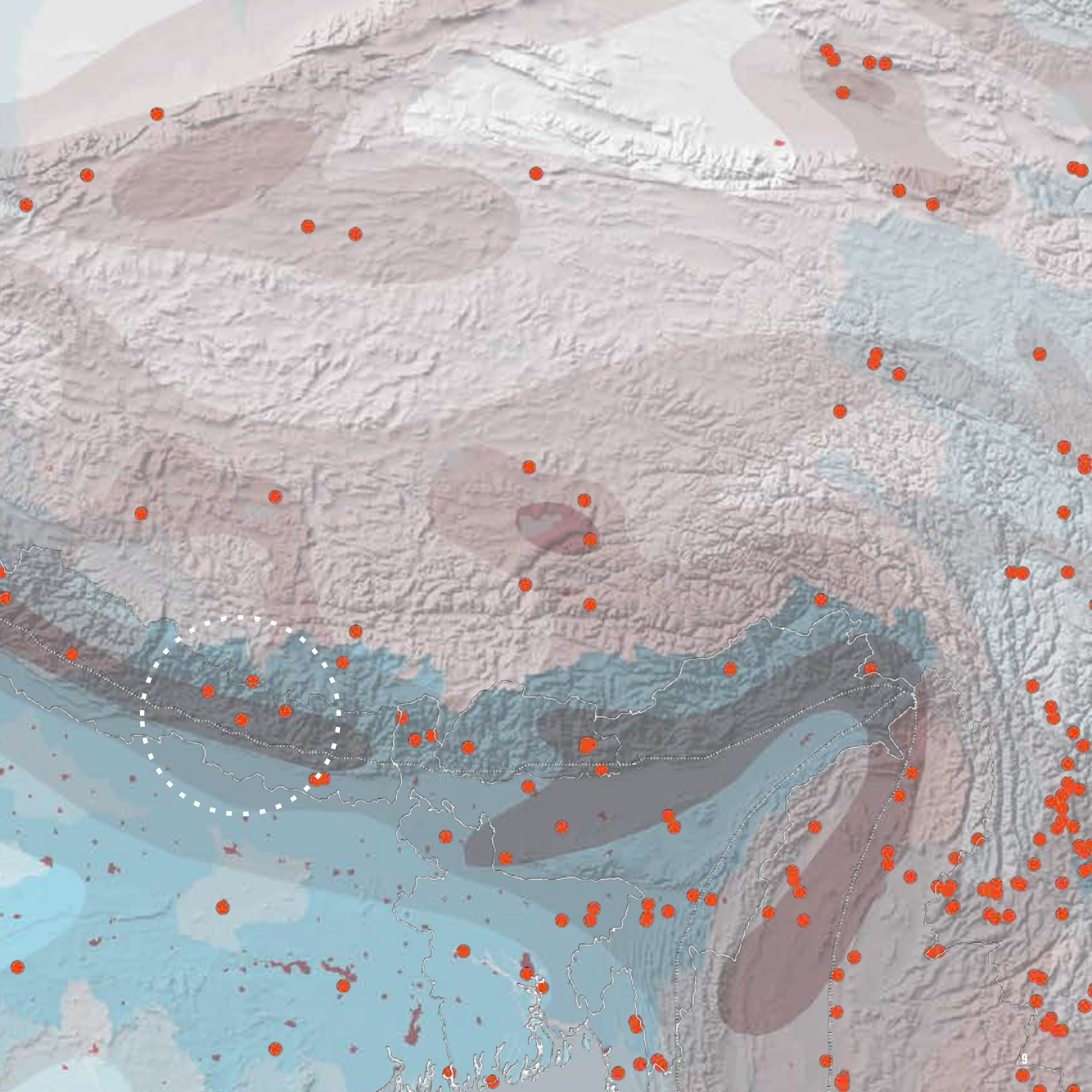



## THE KATHMANDU VALLEY

As the largest urban center in Nepal, the Kathmandu Valley is home to an estimated 2.5 million people with one of the highest population growth rates in Asia of over 4%. “One of the fastest-growing metropolitan areas in South Asia, and the first region in Nepal to face the unprecedented challenges of rapid urbanization and modernization at a metropolitan scale” the Kathmandu Valley’s risk to earthquakes and other geo-hazards an increasingly urgent problem.







**GIVEN NEPAL'S THE RISK TO EARTHQUAKES, HOW CAN THE PUBLIC SPACES OF THE KATHMANDU VALLEY AND THE INFRASTRUCTURE THAT SUPPORTS THEM BE ENHANCED TO STRENGTHEN COMMUNITY RESILIENCE?**

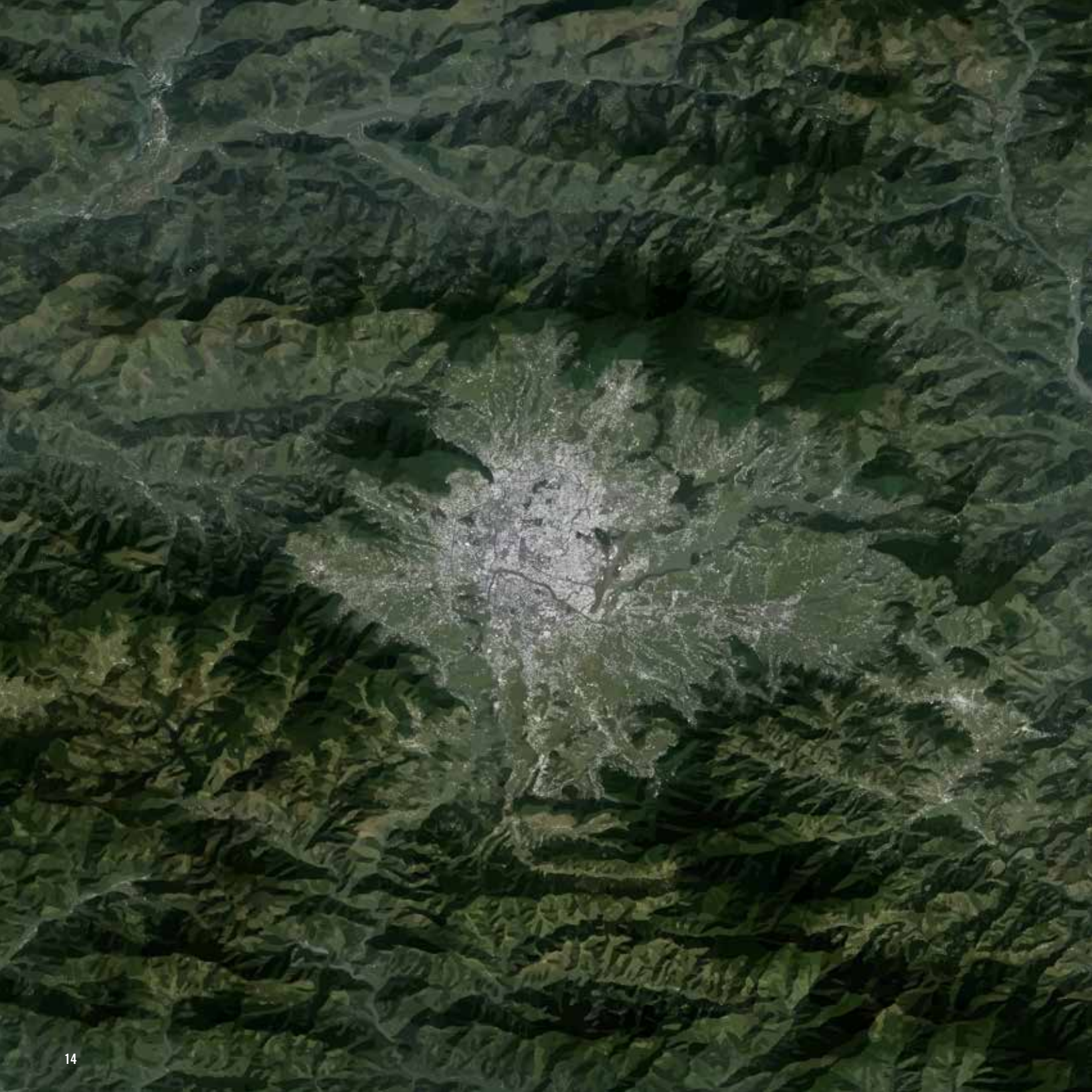

# APRIL 2015 NEPAL EARTHQUAKE

The April 2015 Earthquake in Nepal had serious impacts on the country, with over 9000 deaths and more than double that number in casualties. Occurring on a Saturday morning however undoubtedly decreased the number of deaths that the same magnitude event could have caused during a school day or over night. The catastrophic damage to building stock and infrastructure means recovery and rebuilding will be a lengthy process.

While the epicenter of the earthquake and subsequent aftershocks occurred outside of the metropolis of the Kathmandu Valley, the population density of this area places it at extreme risk to subsequent seismic events.

Added to this is the rate of rapid urbanization and continued sprawl of the valley region which is leading to massive redevelopment where open space is often inadequate. Contrasted with this decline in public space are the traditional settlements on the periphery of Kathmandu which have developed over hundreds to years to have generous public spaces.

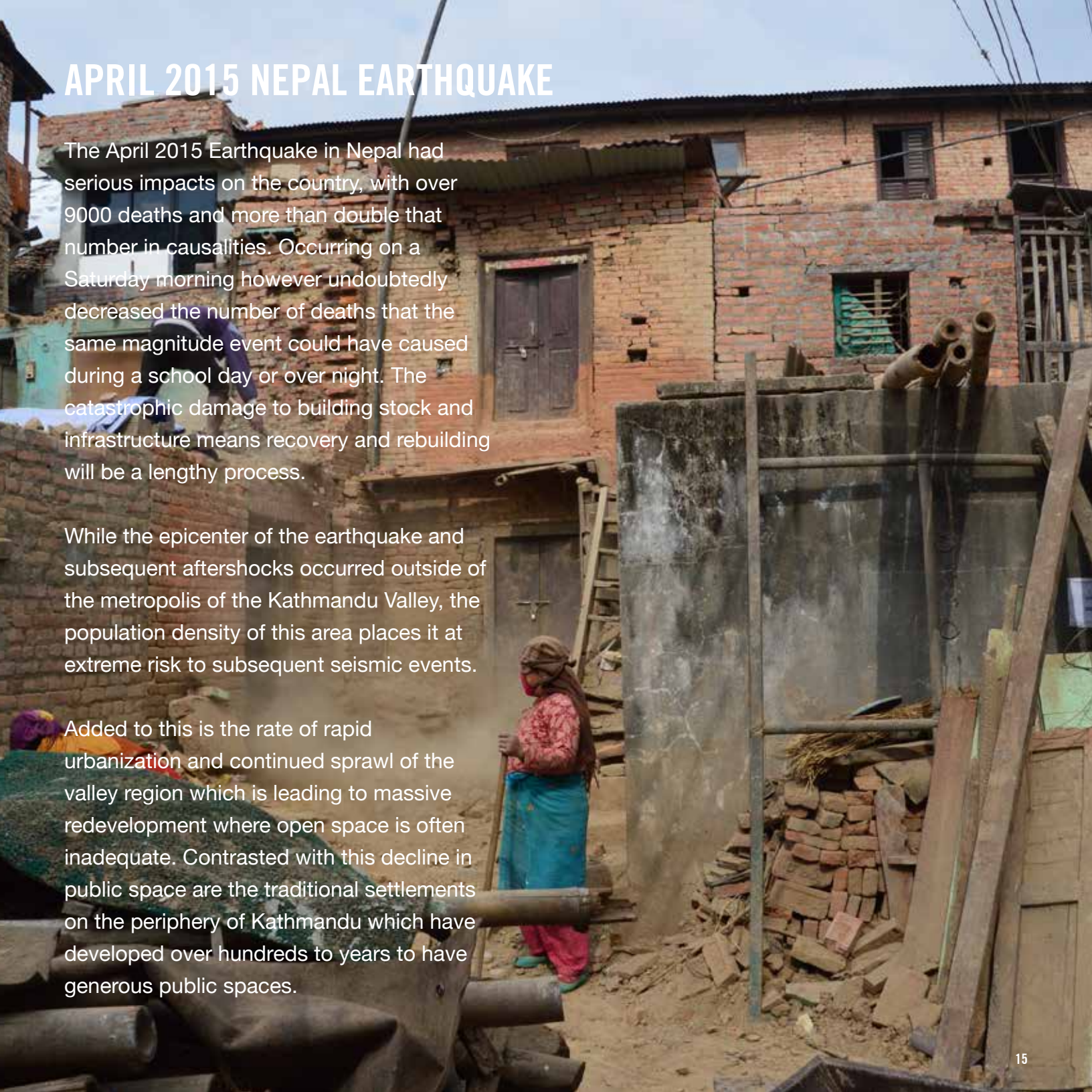

# OPEN SPACE AND PUBLIC INFRASTRUCTURE POST DISASTER

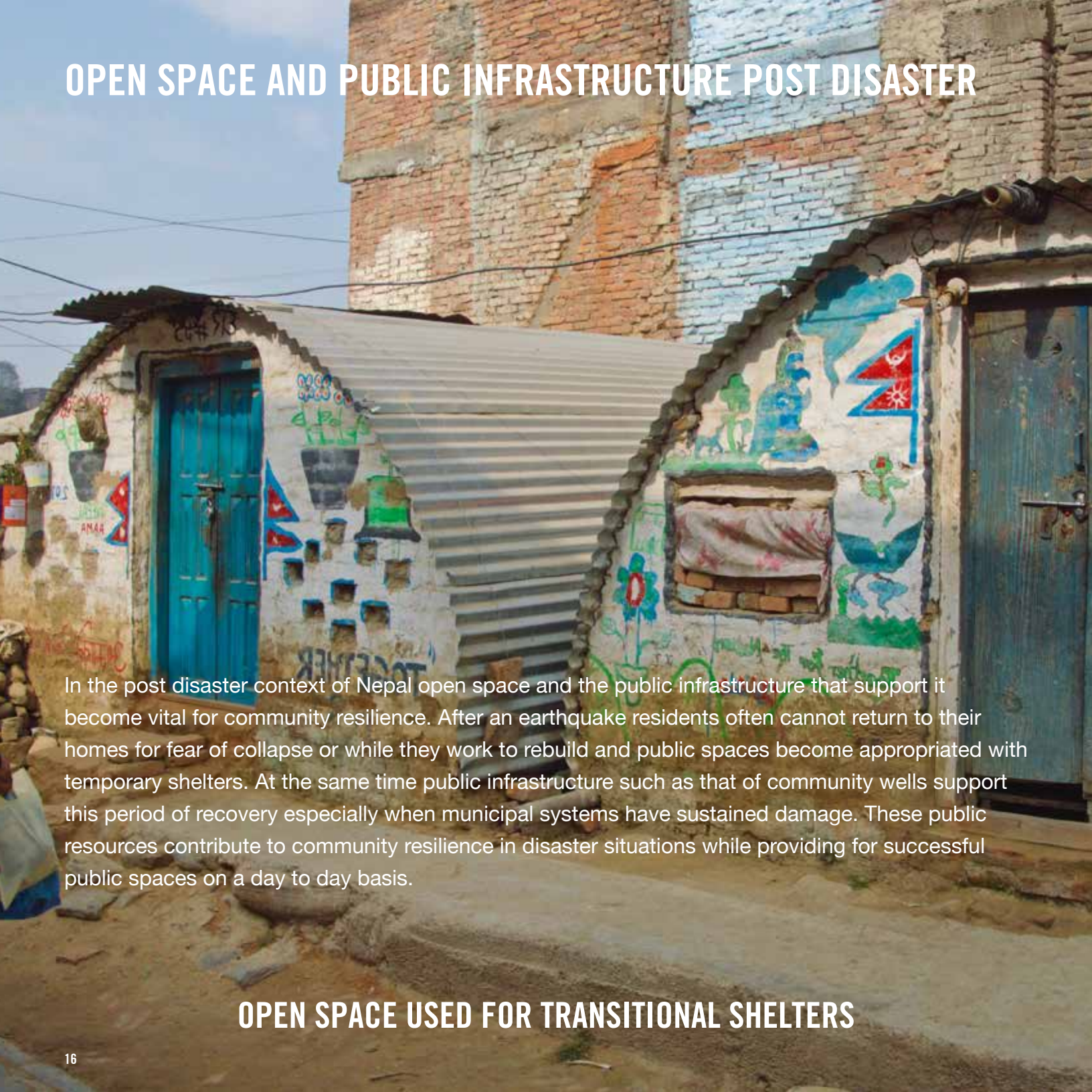

In the post disaster context of Nepal open space and the public infrastructure that support it become vital for community resilience. After an earthquake residents often cannot return to their homes for fear of collapse or while they work to rebuild and public spaces become appropriated with temporary shelters. At the same time public infrastructure such as that of community wells support this period of recovery especially when municipal systems have sustained damage. These public resources contribute to community resilience in disaster situations while providing for successful public spaces on a day to day basis.

## OPEN SPACE USED FOR TRANSITIONAL SHELTERS



INCREASED/CONTINUED RELIANCE ON PUBLIC SERVICES

PHOTOSHOP EDIT/RESIZE



**PUBLIC WELL USED FOR CLEANING AND DRINKING**

# TRADITIONAL OPEN SPACES

## COMMON SCALES OF OPEN SPACE IN NEWARI SETTLEMENTS

MAIN STREET CONDITION 1.

CROSS ROAD INTERSECTION 2.

CLUSTER YARD CONDITION 3.

MAIN SQUARE 4.

PUBLIC POND SPACE 5.

The Kathmandu Valley is home to many of Nepal's cultural groups however is traditionally a Newari settlement. Making up less than 5% of the population of Nepal the Newari people are the historical inhabitants the Kathmandu Valley region and have over the centuries strongly influenced urban space.

Newari settlements share common characteristics such as dense four story homes along narrow streets. Open spaces of different scales define different regions of public use from large squares to tiny court yards.

These spaces are supported by numerous forms of public infrastructure in the form of wells, taps, ancient stone spouts, ponds as well as community gathering spaces and stages, power generation and other public functions.

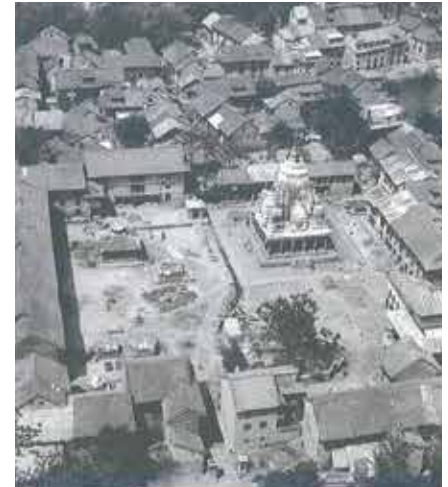



5

1

4

2

3



# PATI

The Pati, a small open air building, is a public infrastructure as old as the ancient settlements of Nepal. Originally built as a resting spot for travelers walking between to villages, Patis are ubiquitous throughout the Kathmandu Valley and its satellite settlements. These buildings are an inherent part of urban life in the Kathmandu Valley and a living example of community managed public infrastructure which is hundreds of years old. As such they have become an architectural and cultural archetypal with hundreds of variations within a few common parameters.

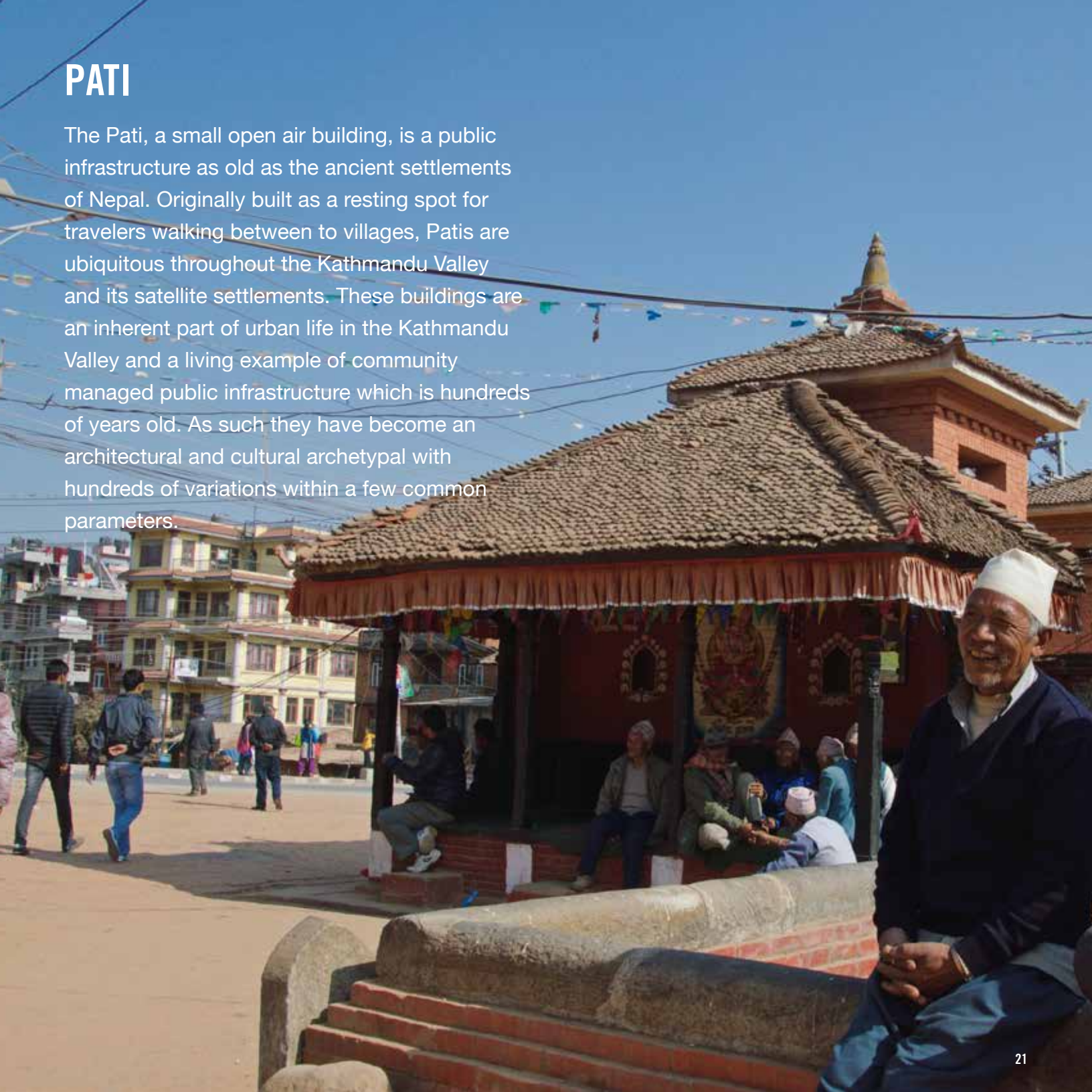

# MULTI PURPOSE COMMUNITY INFRASTRUCTURE - THE PATI

## COMMON FUNCTIONS AND KEY DESIGN FEATURES



EARTHQUAKE RESISTANT



ANCIENT MATERIAL SYSTEMS



CRAFT DESIGN

As a common element of urban space in the Kathmandu Valley, it is easy to overlook the Pati however the multiplicity of functions this, often tiny, structure speaks to its significance and likely relates to its long history of use.

The Pati is first and foremost a shelter. A shelter from the sun and from the rain. The common term “rest house” is used in English to refer to its use as a resting place for travelers; this use remains apt given that homeless people can be seen sleeping there over night before moving in the early morning. Secondly, as a place to sit in the public realm the Pati can see as a social hub where members of the local community engage with each other. Mostly one story, a two story Pati is called Sattal and often houses one room above for community music groups.



SHADE

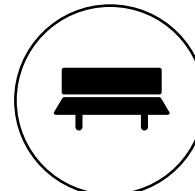

SEATING



WATER ACCESS



RAIN SHELTER

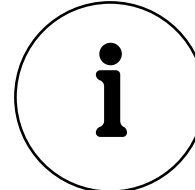

INFORMATION/NOTICES



COMMUNITY ACTIVITIES

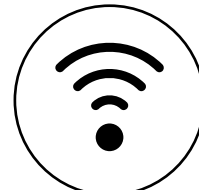

WIFI HOTSPOT



PUBLIC LIGHTING

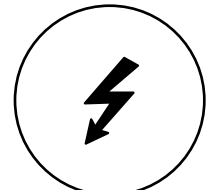

POWER ACCESS



HOMELESS SHELTER



SOCIAL/MEETING SPACE

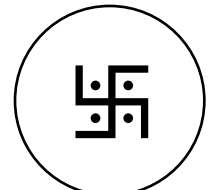

RELIGIOUS ACTIVITIES



REST IS BUT A ONE OF THE USES OF PATI. HOWEVER A MULTIPLICITY OF OTHER FUNCTIONS EXIST THAT CONTRIBUTE TO THE PATI'S SIGNIFICANCE IN THE KATHMANDU VALLEY

# PATI TYPOLOGIES

TYPICAL PATI - OPEN ON THREE SIDES

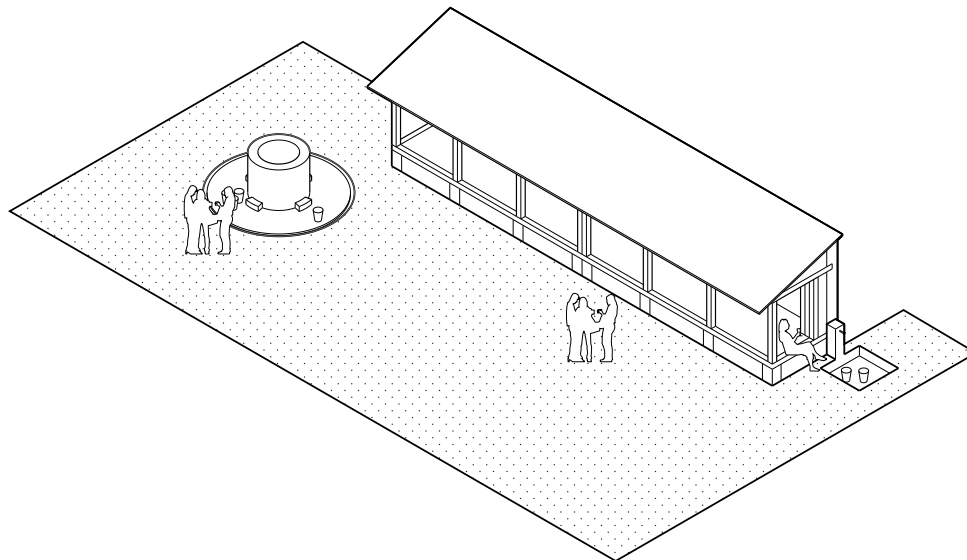
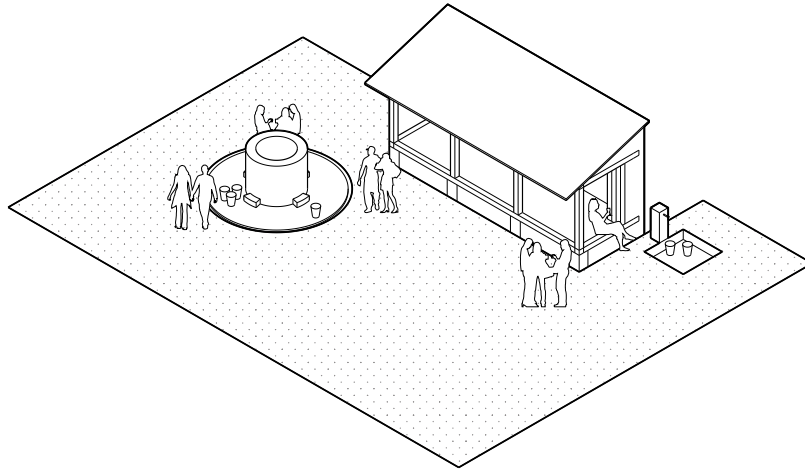

LONG PATI, USUALLY IN LARGE PUBLIC SPACES



LARGER ONE STORY PATI - OPEN ON ALL SIDES

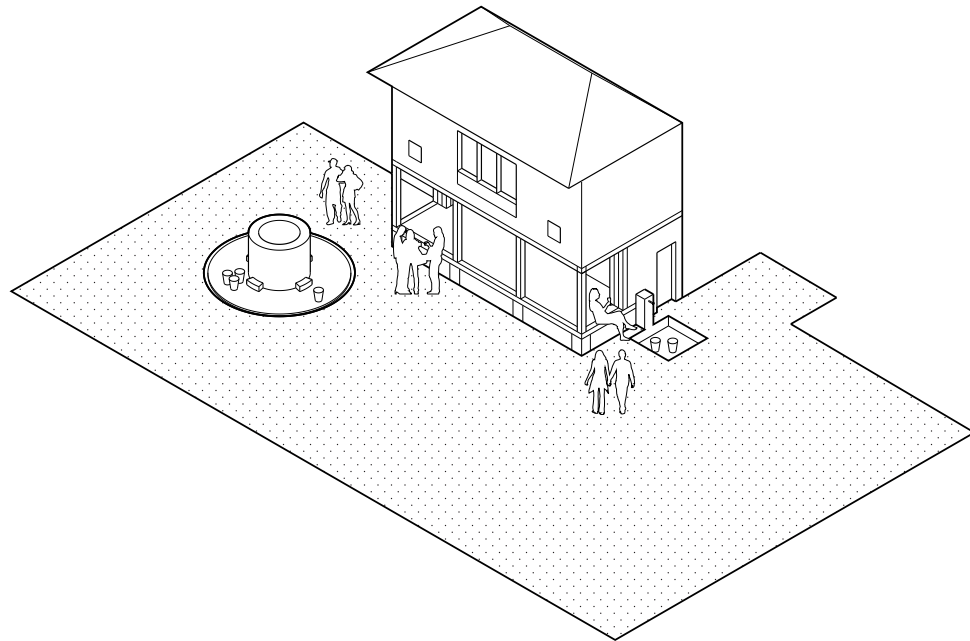
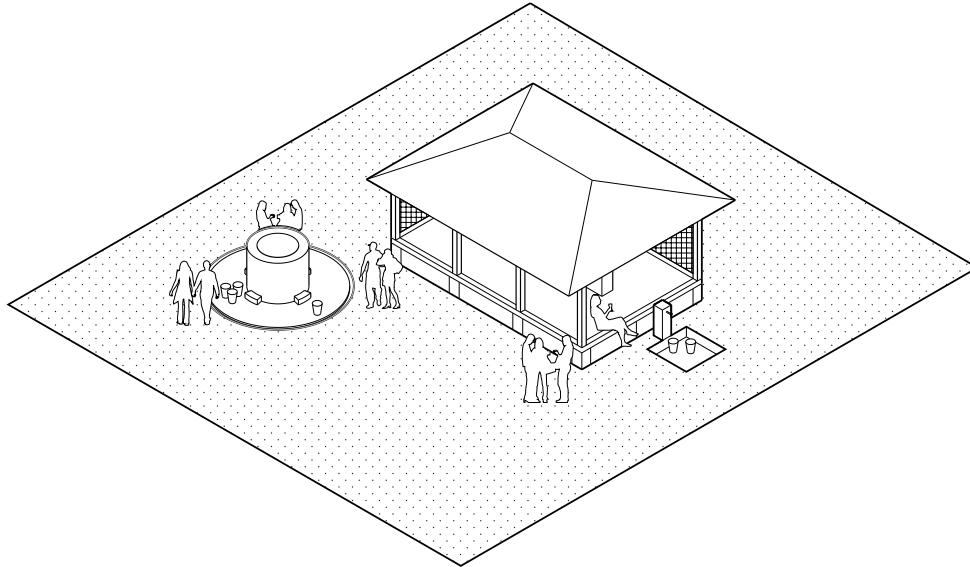

TWO STORY PATI ("SATTAL") - OFTEN

# CONSTITUENT PARTS

## COMMON ISSUES

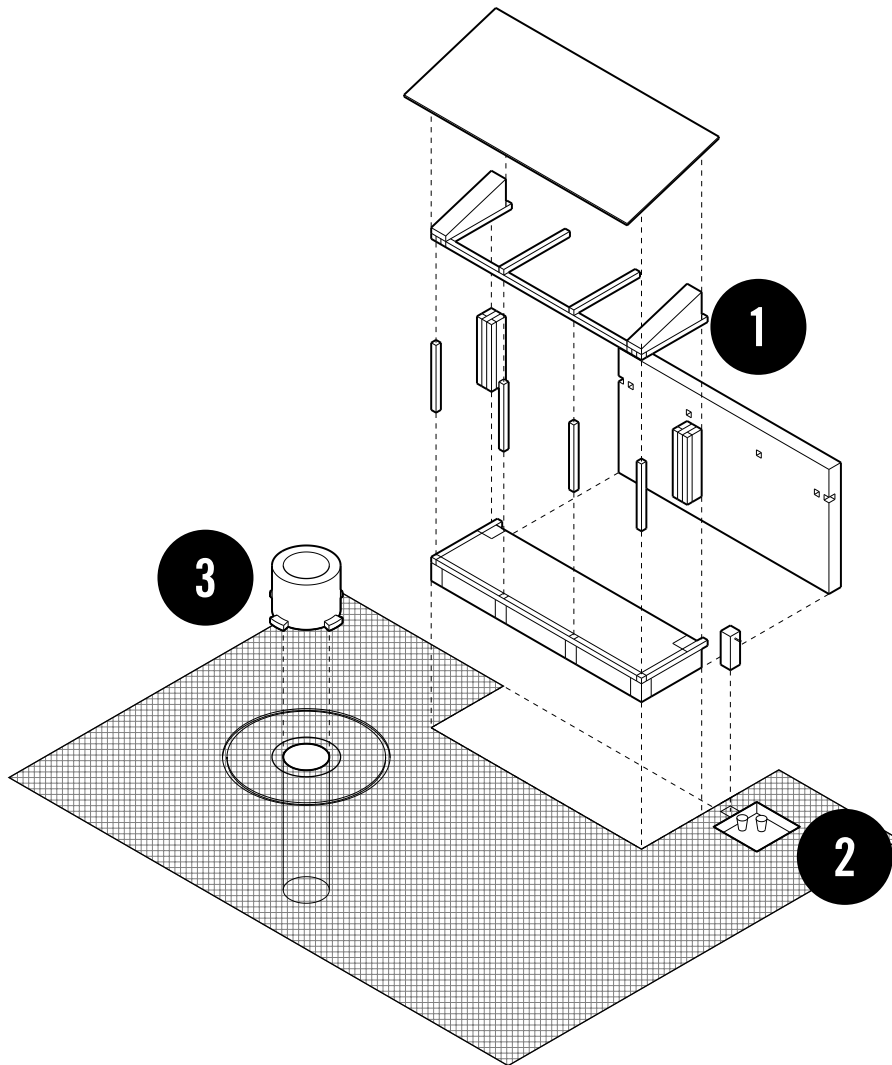

### 1. PATI

CAGED TO PREVENT THEFT/ENCROACHMENT, DAMAGED OR DESTROYED, NO REMAINING GUTHI OR LACKING FUNDS TO MAINTAIN

### 2. PUBLIC TAP

DUAL PIPES, MUNICIPAL AND PUBLIC SOURCES, INFREQUENT SUPPLY, TREATMENT, STORAGE, DRAINAGE

### 3. PUBLIC WELL

POWER, TREATMENT, CONTAMINATION, STORAGE

DISCRETE ELEMENTS OF TYPICAL PATI

## POTENTIAL SOLUTIONS



WARNING SYSTEM



WATER PUMP

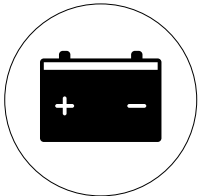

POWER STORAGE



WATER STORAGE



WATER TREATMENT

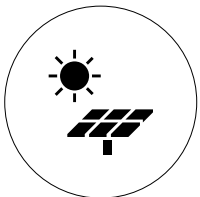

SOLAR TECHNOLOGY

## ZONES FOR EMBEDDED INNOVATION

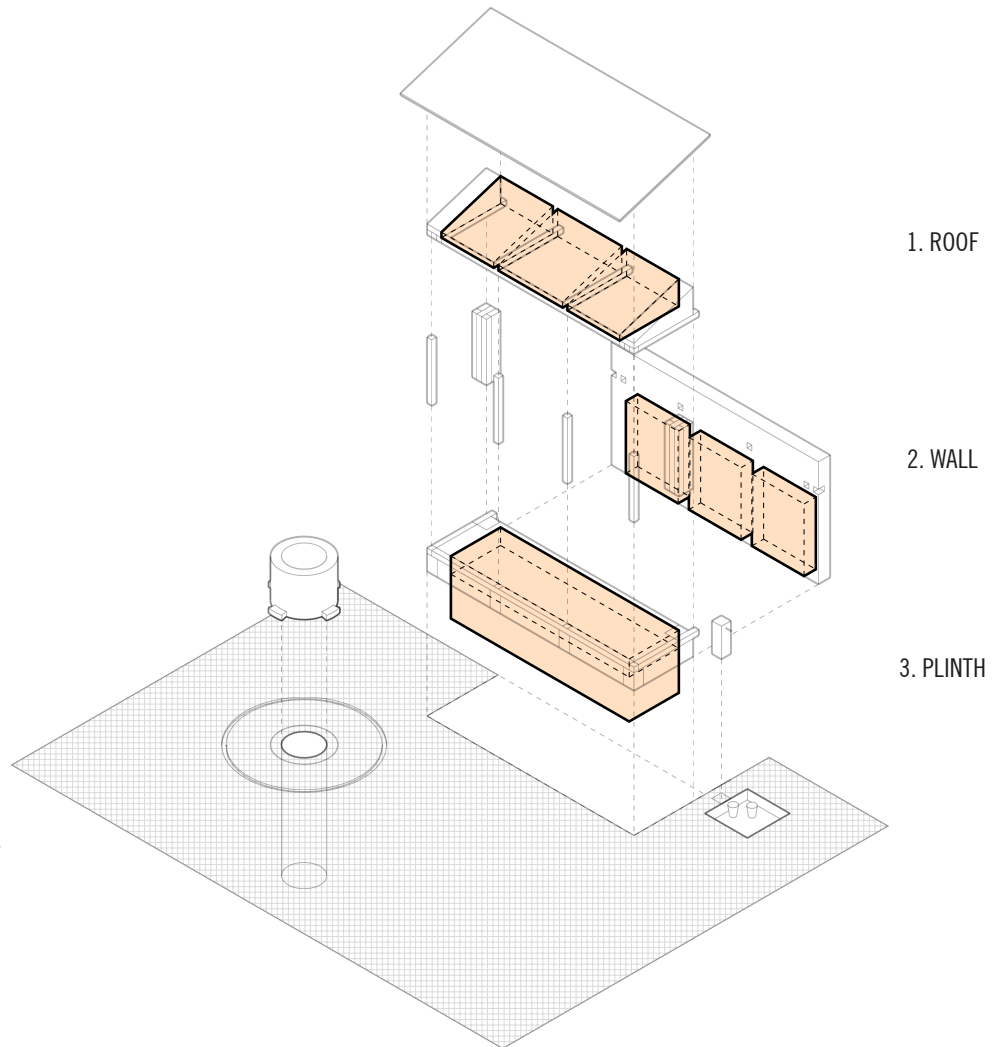

POTENTIAL ZONES OF EMBEDDED INNOVATION

# GUTHI SYSTEM - TRADITIONAL MANAGEMENT

One of the oldest living social systems in Nepal is that of the Guthi System. Not unlike a co-operative, Guthis are a community management system with elders and committees for carrying out common activities. Established to manage and maintain temples and other kinds of public buildings and infrastructure, Guthis exist in many forms from that of family name, to neighborhood based, to sector based such as the maintaining of water supply systems.

Traditionally land was donated to the Guthi in order to generate the income necessary to carry out the work however this hinterland connected to the organization of the Guthi has decreased significantly over the last 50 years. The result being the diminished capacity of the Guthis in many settlements.

Many Guthis remain active for temple maintenance, festival and religious activity management and often responsible for the maintenance of a Pati, however vast numbers of Patis exist without any active Guthi contributing to the continued degradation of these public buildings.





## BUNGAMATI SITE A - MAIN STREET

This site is situated along a main street of Bungamati. The original Pati was destroyed and rebuilt using concrete and steel and currently houses bricks and from demolished homes. Connected to the Pati is a mid-sized concrete water storage tank connected to a municipal pipe line. The tank is damaged and is not currently storing water. Adjacent is a plaster tank which is used by some residents. The local community and residents directly adjacent expressed an interest in the Pati returning to its original size and embedded water storage under it.







## BUNGAMATI SITE B - CROSS ROAD

A two story Sattal, adjacent to a large concrete water tank, this rest house was rebuilt before the earthquake but caged and without public access. Two community groups on the two floors played music however as the house to the rear owns the shared wall and must demolish it, the Sattal will also be demolished. This site is interesting as its at a nexus of two street, two rest houses, an open space for events, a water tank (thats not currently functioning) and a well. Additionally the site was home to an ancient Hiti which was backfilled after the 1934 earthquake.







राज  
वीजाकल  
मिति-  
समाज  
का मुल्य  
ट.संग

समाज  
का मुल्य  
ट.संग



## BUNGAMATI SITE C - CLUSTER

The third site in Bungamati is the smallest both regarding its physical dimensions but also regarding its potential use by the surrounding residents. Situated within a tight cluster ten households use this space to access the well. The water is not currently potable, and a plastic tank sits on top of the well which is periodically filled by a neighboring resident who has a piped water connection in their home. This generosity of water sharing has a long history in Nepal, one which appears to be living.







## **KHOKANA SITE A - CROSS ROADS**

In the neighboring settlement of Khokana, (the first settlement in Nepal to have electricity supply as well as one of the earliest to have a water distribution via stone spout) has one site where three roads meet. Two Patis which were built as a pair face onto the public space where a well used for washing purposes sits. The municipal water supply is piped into this well which is therefore no longer potable. A pump connected to a neighboring home is used periodically to fill two water tanks which have replaced the concrete one destroyed in the earthquake.







## THIMI SITE A - CROSS ROADS

The site on the main road of the settlement of Thimi has a small pati, water tap and a large open (potentially natural) drain. The local Guthi has locked the Pati for fear of encroachment from a resident trying to establish a shop. There is the potential to add another floor and convert it into a Sattal and a willingness to remove the caged doors if the sense of encroachment was removed. A stone inscription was stolen from the Pati, thought to be an attempt to challenge the legitimacy the building's age which is over 100 years.







## LUBHU SITE A - PATI BY THE SHOP

There are two water distribution points in the vicinity of this Pati. One almost touches it while the other is about 12' away. The one that's close is a potable water source. The other is newer and has the same split system of potable and washing. The system distributes water from about 4am in the morning for a few hours. The Pati is managed by a Guthie who operate two festivals two days a year.







## GOING FORWARD

I will be returning to Nepal during summer 2016 for an extended period. Until the summer, a key project milestone is the development of the prototype design. Concurrently we plan to carry out water tests at particular sites to help develop the treatment approach the project could take. Additionally, research on the scale, cost and feasibility of the potential technologies that could be embedded into the Pati will be carried out to begin developing strategies for deployment of the prototype.

## THANKS

During the formative and early stage of this project, I would like to express my gratitude to the people in Nepal that helped facilitate and inform the direction of the work. Thanks must go to the people of Bungamati, Khokana, Lubhu for their time in answering questions. Thanks to Yogeshwar Parajuli, Director of KVDA and Nilima Shrestha for her time to guide me around her home of Thimi.

A special thanks must go to Purna Kadariya for connecting us with numerous contacts in Nepal, without which our trip could not have been so successful.

Thank you to Dr. Sudha Shrestha and Sanjaya Upreti of the Institute of Engineering, Center for Urban Planning Studies who generously gave their time to discuss the project. A special thanks must go to Rakesh and Anil, who gave so much of their time to guide me around the settlements of Kathmandu Valley.

Finally I would like to thank Bigyan Raj Bista and Subarna Basnet for their support over the last number of months in planning the trip to Nepal, connecting us with local stakeholders and helping to refine the project ambitions.

